



CAUTION

- Do not use impact force when installing strip.
- Strip flexes only on one axis.
- Do not twist strip.
- Do not attempt to bend the strip on the wrong axis.
- Observe minimum bend radius.
- Do not bend the first or the last sections of the strip.
- Installation should only be performed by a qualified professional.
- Install in accordance with all appropriate wiring standards.
- DALI is not SELV and needs to be wired accordingly.
- Never connect a LED luminaire to a driver that is powered. Doing so may result in damage to the LED.
- Always make sure the output voltage range and output current of the LED driver match the requirements of the LED luminaire. Failure to do so may result in damage to both the driver and the luminaire.
- The light source contained in this luminaire shall only be replaced by the manufacturer, specified service agent or a similar qualified person.
- Do not install under mechanical stress.
- Allow for expansion due to changes in temperature.
- Please be aware that while the system has a very long operational life, faults may occur, and provision needs to be made for maintenance.
- Always turn off power before working on luminaire.

Overview

Front Lit

Dimensions	16mm x 17mm
Length	Custom
Weight	500g/m
Minimum Bend Radius	150mm

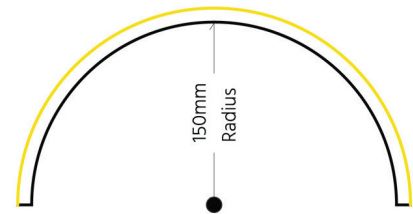
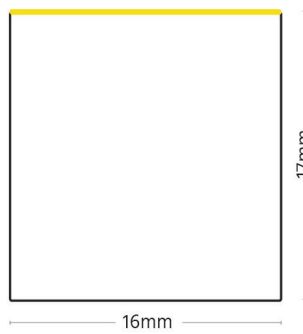
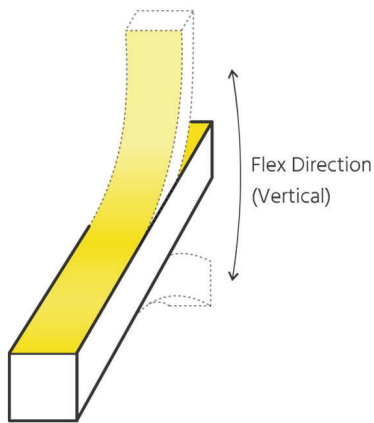

*Refer to page 3-4 for installation and wiring diagram.

Side Lit

Dimensions	16mm x 17mm
Length	Custom
Weight	500g/m
Minimum Bend Radius	150mm

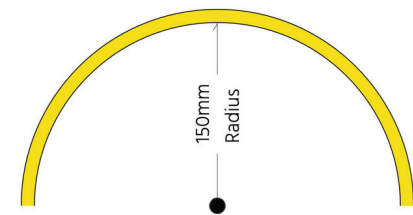
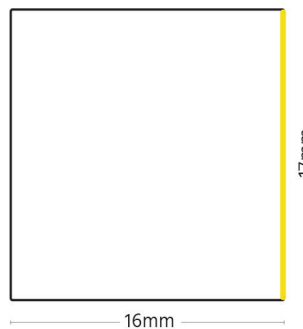
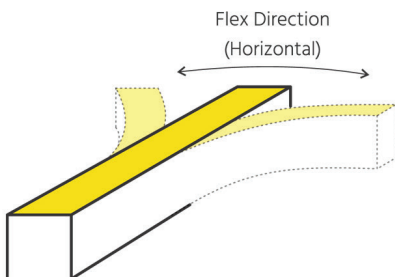

*Refer to page 3-4 for installation and wiring diagram.

Installation - Mounting Profile and Mounting Clips

Wiring Diagram



Note: Drivers should not be covered. Drivers rely on convection air flow for cooling and covering them may cause them to enter thermal regulation.

Recommendations

- Mounting clips are to be spaced 150mm apart for the length of the strip. Keep 30-40mm distance between the end cap/power connector and mounting profile/mounting clip.
- Ensure profile junctions align.
- For lengths over 2m, it is recommended that installation be carried out by 2 people. 1 to mount the strip, the other to support the tail to avoid incorrect or excessive bending and twisting.
- Ensure not to damage the outer jacket during installation.
- Do not remove the anti-wicking ferrule.

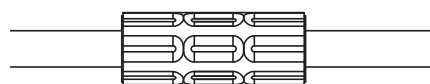

Anti-wicking Ferrule

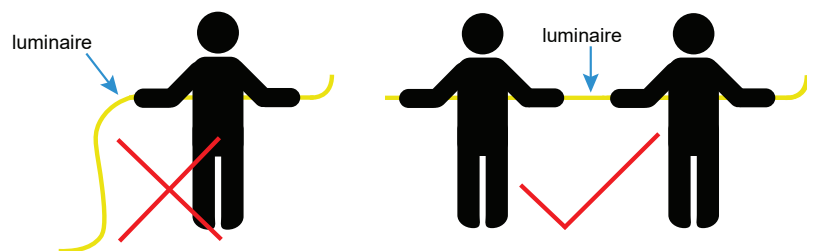

Installation Process

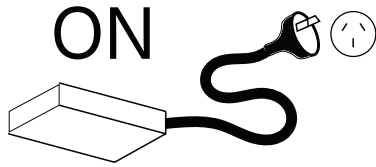

1. Prior to installation, connect power to the strip to confirm that the entire length is functioning. Do not run for more than 1 minute while coiled.

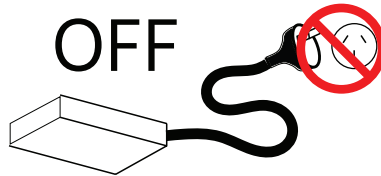

2. Disconnect power before continuing with installation.

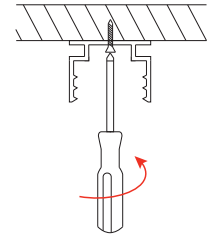

3. Install the mounting profile/clips into position as required using suitable anchors. Ensure nothing protrudes beyond the mounting base for the LED strip.

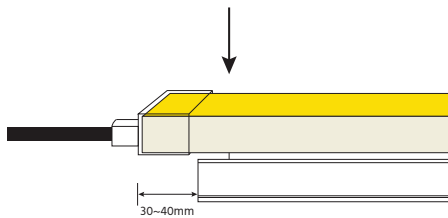

4a. Starting at one end, set the strip in place with the minimum distance between the end cap/power connector and mounting profile/clips.

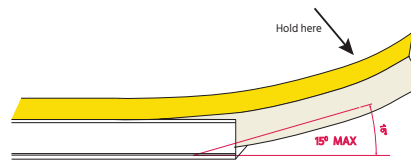

4b. With one hand, maintain a maximum angle of 15° between the strip and mounting profile.

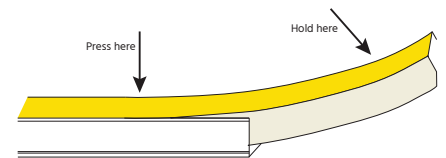

4c. With the palm of the other hand, gently press the strip into the mounting profile. Do not use a striking force. Avoid using fingers.

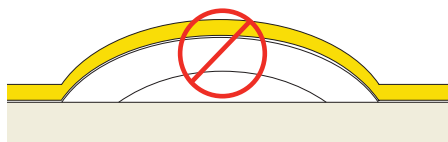

5. Continue for the full length of the strip in one direction. Do not attempt to install from 2 ends.

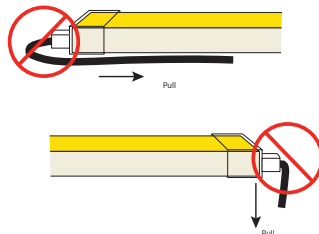

6. Connect to power. Do not place excessive strain on the cable entry.

Note: Drivers should not be covered. Drivers rely on convection air flow for cooling and covering them may cause them to enter thermal regulation.